

LF3-HL SERIES Outdoor Lighting

LF3-HL-230W-40K-480V
LF3-HL-230W-50K-480V

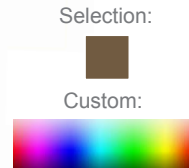

Customer Name: _____
Project Name: _____
Note: _____ | Type: _____

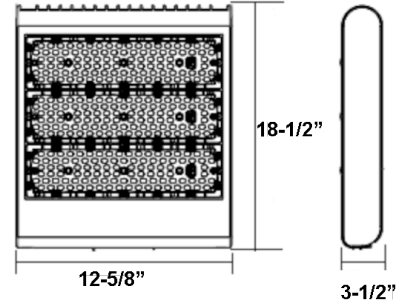

18-1/2" (H) x 12-5/8" (W) x 3-1/2" (D)

Ideal for general site lighting, alleys, loading docks, doorway, pathway, and parking areas.

Features

- DLC Premium & LED High-Lumen Floor lights
- Solid State Lighting Technology for Long Life
- No Maintenance Needed and High-Efficiency
- 70,000 Hours Rated Life
- 7-Year Warranty
- Lens: TYPE II, III and IV Optic Lens

Technical Specifications

Electrical:

- Voltage: 480V
- Wattage: 230W
- Power Factor: >0.9
- Efficacy: 130~134 LPW

Mechanical:

- With Snap-on & Bolt Mounting Options for One-Person Installations. Select a Mounting Option (Sold Separately)
- Die-cast Aluminum Housing with Powder Coat Finish (Dark Bronze)
- IP Rating: IP65
- Effective Projected Areas (EPA's) are:
Front = 0.38 ft², Side = 0.40 ft², Face = 1.45 ft²
- Operating Temperature: -40°F to 104°F
- Suitable for Wet Locations

Lighting:

- Dimming: 0~10V dimmable
- Optic Lens Type: III (Type II with "U" Bracket)
- LED: Philips Lumileds Luxeon 3030 High Flux LED
- Cord Type: 6' SJTW 18/3 AWG cable
- Total Lumens: 30000LM
- Color Temperature: 4000K/ 5000K
- Color Rendering index: ≥ 82
- Beam Angle:
Type 2=120°X90° | Type 3=140° x80° | Type 4=140°x100°

Applications:

- Ideal for general site lighting, alleys, loading docks, doorway, pathway and parking areas.
- Replace existing HID flood lights/ wall packs

Other Models:

- 40W | 13200LM | LF3-HL-100W-40K-480V
- 50W | 13300LM | LF3-HL-100W-50K-480V
- 40W | 20680LM | LF3-HL-150W-40K-480V
- 50W | 20680LM | LF3-HL-150W-50K-480V
- 40W | 39000LM | LF3-HL-300W-40K-480V
- 50W | 39000LM | LF3-HL-300W-50K-480V



Photometrics: LF3-HL-230W-480V

TYPE III (TYPE II & TYPE IV see page 4)

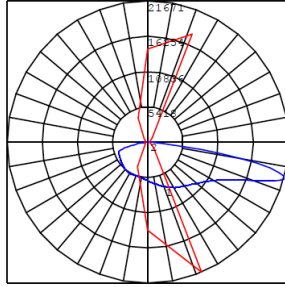
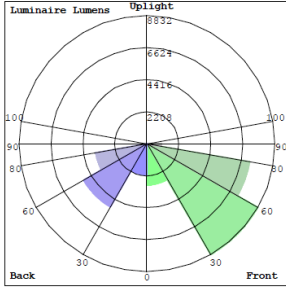

BUG Rating: B4-U0-G5

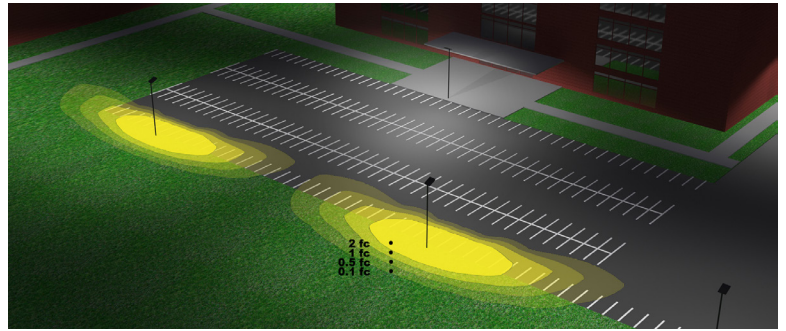

Area 100'x 215' Mounting Height: 20'

Other Views:

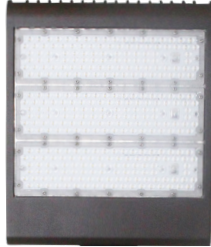

Front View



Side View



Back View

Performance Table: LF3-HL-230W-480V

MODEL NO.	Wattage	Voltage	Lumens	Color Temp.	BUG Rating	LPW
LF3-HL-230W-40K	230W	480V	30000LM	4000K	B4-U0-G5	130
LF3-HL-230W-50K	230W	480V	30000LM	5000K	B4-U0-G5	130

Sample Ordering

- - -

40K = 4000K
 50K = 5000K

Accessories Options

Blank = No Option for Accessories
 WEC-7RC = Remote Control for OPT-SEN-3MR-4
 *REFER TO PAGE 3 FOR MOUNTING OPTIONS

Factory-Installed Options

Blank = No Factory Installed Options
 OPT-LF3-PCK = Twist Lock Photocell
 OPT-SEN-3MR-3 = Programmable Microwave BI-Level
 OPT-TLSOC7P = 7-Pin Receptacle Kit to accept Smart Control Twist-Lock Photocell (Photocell not incl.) (Shorting Cap incl.)
 OPT-CLR-95 = Color Paint

Example:

- LF3-HL-230W-40K-480V (For LF3 230W 4000K fixture 480V)
- LF3-HL-230W-40K-480V WEC-7RC (For LF3 230W 4000K fixture 480V) (For Remote Control)
- LF3-HL-230W-40K-480V WEC-7RC OPT-SEN-3MR-3 (For LF3 230W 4000K fixture 480V) (For Remote Control) (For Programmable Microwave BI-Level Motion Sensor)

SENSOR AND REMOTE CONTROL OPTIONS



LF3-HL-PCK
Twist-Lock
Photocell + Receptacle Kit



OPT-SEN-3MR-3
Bi-Level Motion
Sensor



WEC-7RC
Remote control



OPT-TLSOC7P
Smart Control
7-Pin Receptacle Kit
(Photocell not incl.)
(Shorting Cap incl.)



Smart Control
7-Pin Receptacle Kit
for
OPT-TLSOC7P



Mounting Options: Refer to Mounting Spec Sheet for Detail



LF3-HL-SF

Adjustable Slip Fitter for Pole Mount 2" - 2 1/2"



LF3-HL-YK

Yoke
6 1/2" (W) x 5 3/4" (H)



LF3-HL-EXTARM

Straight extension arm for shoe box application
3 3/4" (W) x 7 1/6" (H)



OPT-LF3-HL-TR

"U" Bracket
13 1/4" (W) x 7 3/4" (H)



LF3-HL-RA

Rectangular Arm
3 3/4" (W) x 8 4/5" (H)



LF3-HL-FSF

Fixed Slip Fitter for Pole Mount 2" - 2 1/2"



LF3-HL-ASA

Adjustable Straight Arm
2 1/4" (W) x 8 3/4" (H)



LF3-HL-RSF

Modern Adjustable Slip Fitter for Pole Mount 2" - 2 1/2"



LF3-WMA + LF3-HL-RA

Spaced Straight Surf. Mount
5 1/4" (W) x 9" (H)



LF3-WMA + LF3-HL-EXTARM

Straight Surf. Mount
5 1/4" (W) x 7 1/3" (H)



LF3-WMA + LF3-HL-ASA

Adjustable Surf. Mount
5 1/4" (W) x 8 1/2" (H)



LF3-WMA + LF3-HL-RA

Close-to-Wall Surf. Mount
5 1/4" (W) x 2 1/2" (H)



LF3-HL-PMR

Round Pole Mount
6 1/4" (W) x 7" (H)



LF3-HL-PMS

Square Pole Mount
6 1/4" (W) x 7 1/4" (H)

Shroud & Wire Guard: LF3-HL-230W



LF3-SH4

Shroud (Reversible)



LF3-SH4FG

Full Glare shroud



LF3-WG4

Wire Guard

Color Option: LF3-HL-230W

Custom color available

Black Silver White **Dark Bronze** Green Red Yellow
Default color



Lens Type Specifications:

- Optical PC Precision lenses designed for Westgate LF3 Series Flood Lights
- These lenses are replaceable by the factory or field replaced by installers

Lens Type Options:



LF3-HL-TYPEII-230W = TYPE 2 lens for LF3-HL series 230W (3/Order)
 LF3-HL-TYPEIII-230W = TYPE 3 lens for LF3-HL series 230W (3/Order)
 LF3-HL-TYPEIV-230W = TYPE 4 lens for LF3-HL series 230W (3/Order)

Lens Type Explained

SELECTING THE BEST DISTRIBUTION TYPE FOR YOUR OUTDOOR PROJECT

- “Distribution Type” defines how far forward of the luminaire (i.e., on the StreetSide) the effective output reaches

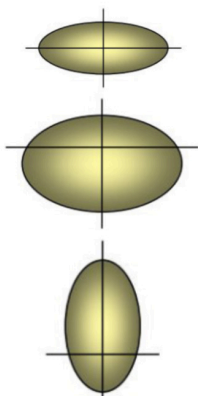

- Type 2 is still linear but wider in the front to accommodate 4 lane roadways or wider drive lanes
- Type 3 (commonly known as a “Bat-Wing”) is suitable for perimeters, often where other interior pole placements fill the site
- Type 4 (commonly known as a “Forward Throw” or Asymmetric) Is best along perimeters where spill light is a concern or there are no place to add poles within a site

Photometrics: LF3-HL-230W-480

TYPE II

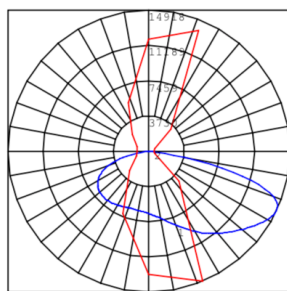
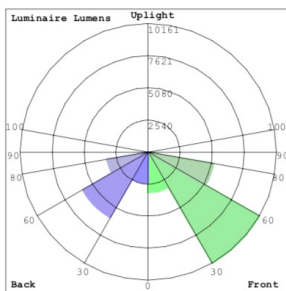

BUG Rating: B4-U0-G4

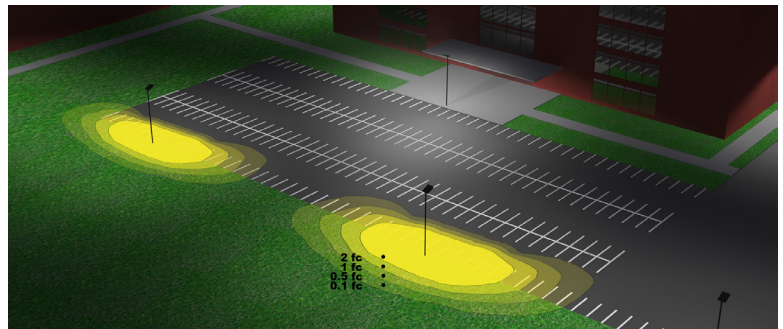

Area 90'x 180' Mounting Height: 20'

TYPE IV

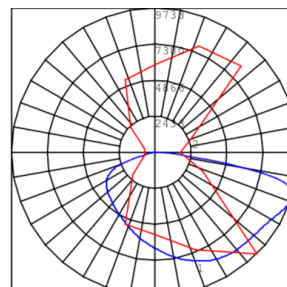
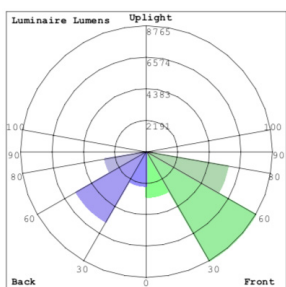

BUG Rating: B4-U0-G4

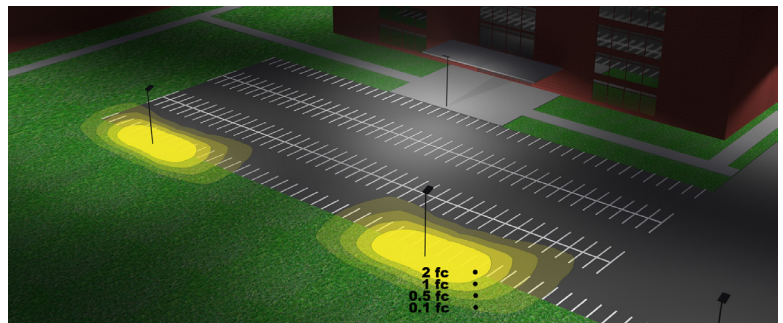

Area 113'x 155' Mounting Height: 20'

